

# HARDWARE TYPE R-40

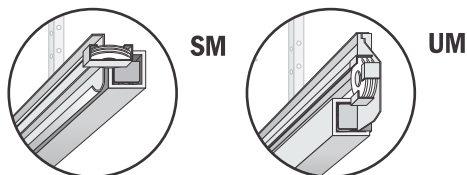

R40 track system comes fully preassembled with tension springs, cables and accessories. The door with R40 type hardware is very easy and fast to install. Maximal R40 door measurements 3000 x 2500 mm.

R40 SM type hardware with side mounted spring system looks very compact and gives more height space inside the garage. Requires only 80 mm headroom (120 mm with operator), 75 mm side-room at the opening and 80 mm more 270 mm behind the opening wall.

R40 UM type hardware with spring system mounted under horizontal track requires minimal side-room space - just 75 mm all the way long. The same, only 80 mm headroom is required (120 mm for electric operated door).

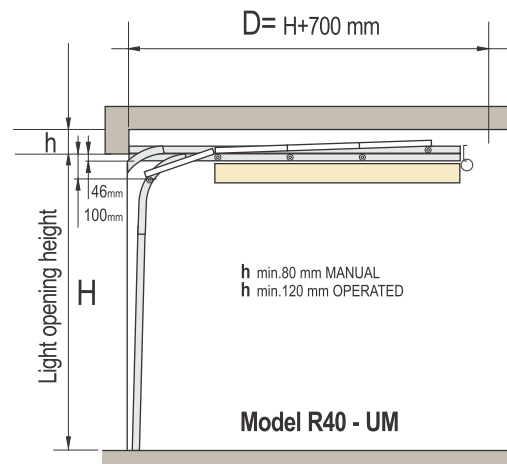
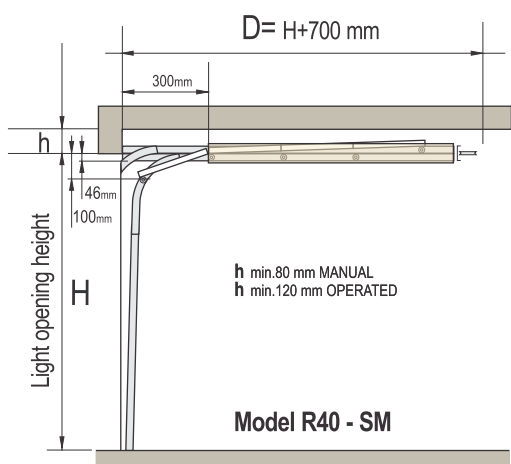
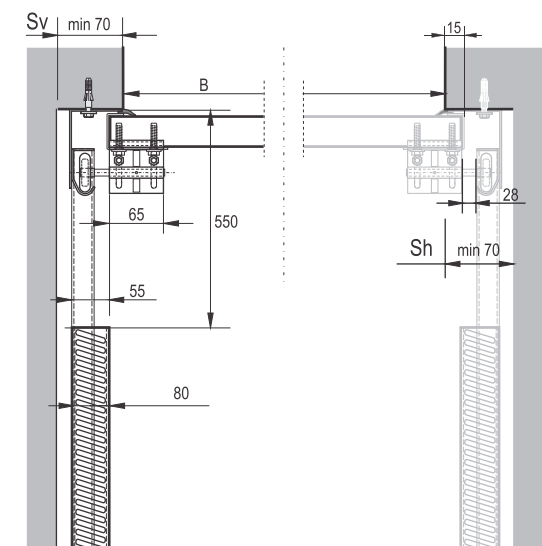
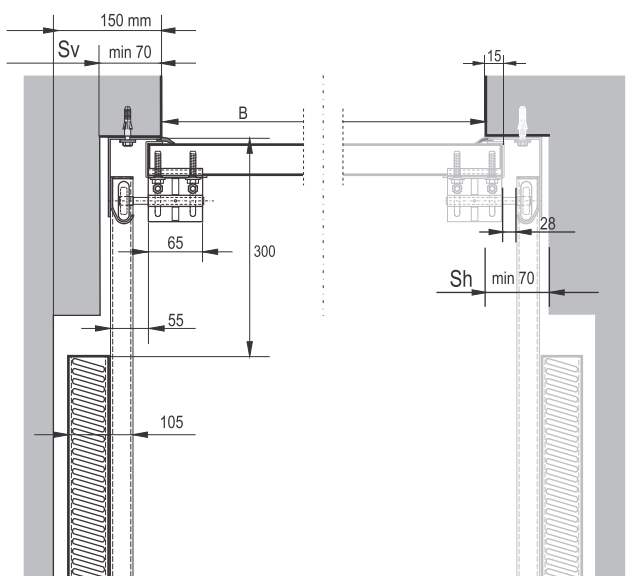

# HARDWARE TYPE TL

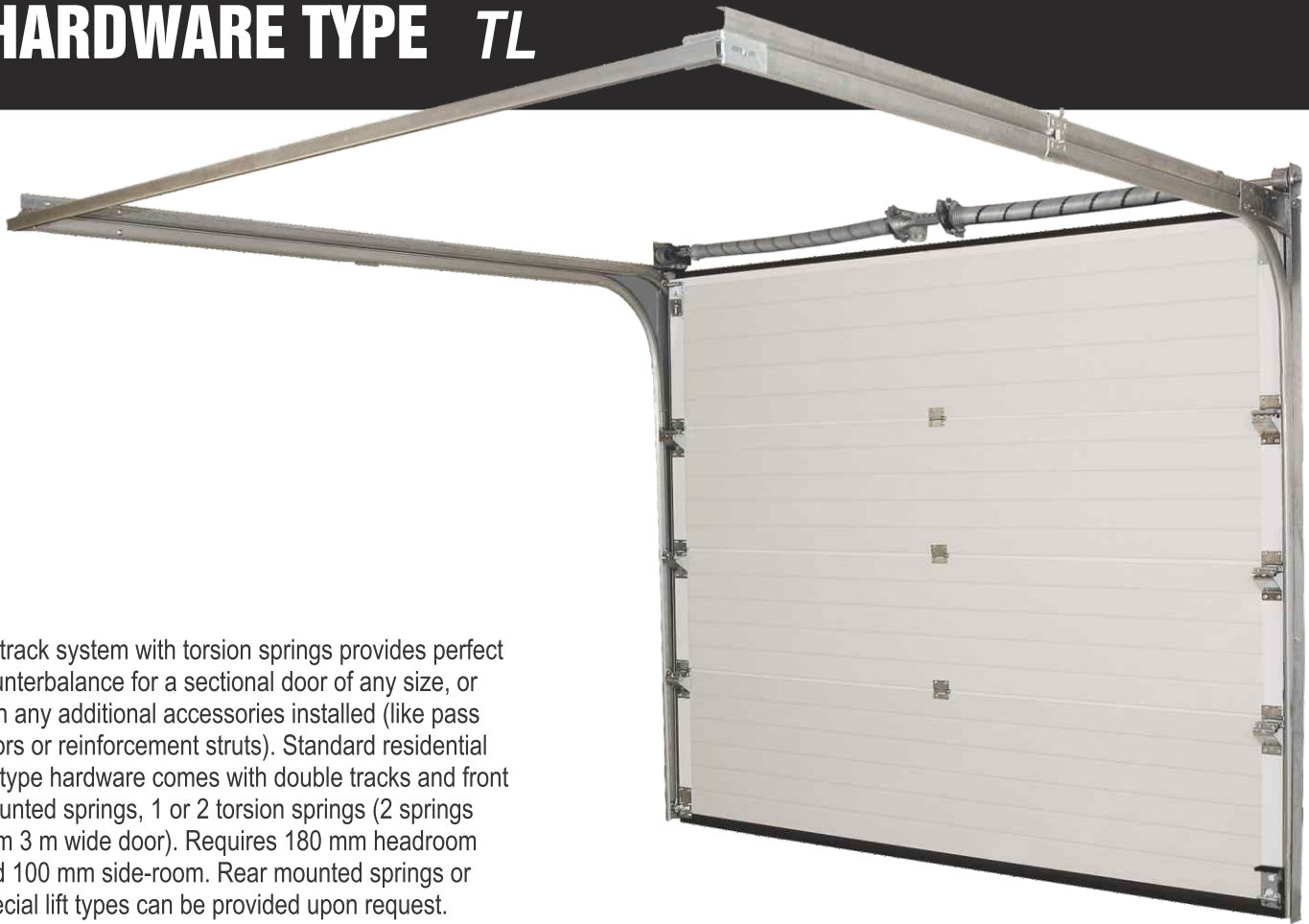

TL track system with torsion springs provides perfect counterbalance for a sectional door of any size, or with any additional accessories installed (like pass doors or reinforcement struts). Standard residential TL type hardware comes with double tracks and front mounted springs, 1 or 2 torsion springs (2 springs from 3 m wide door). Requires 180 mm headroom and 100 mm side-room. Rear mounted springs or special lift types can be provided upon request.

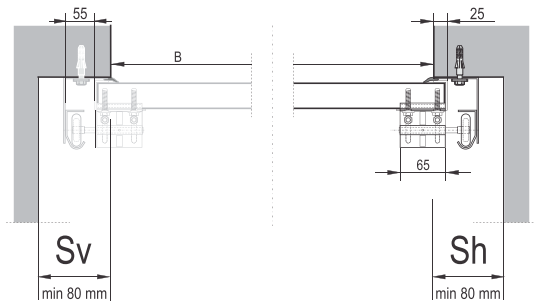

## UNDER REQUEST

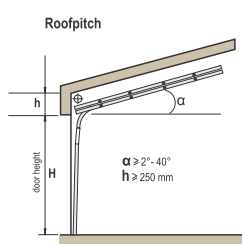
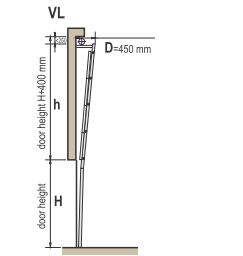
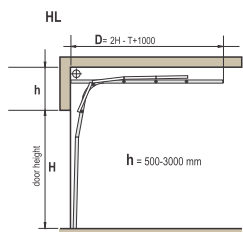
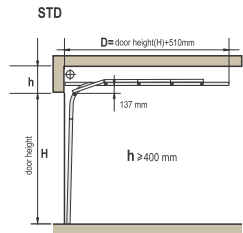

**LHR FM** - low headroom lift double tracks, front mounted springs

**LHR RM** - low headroom lift double tracks, rear mounted springs

