

HARDWARE TYPE TL

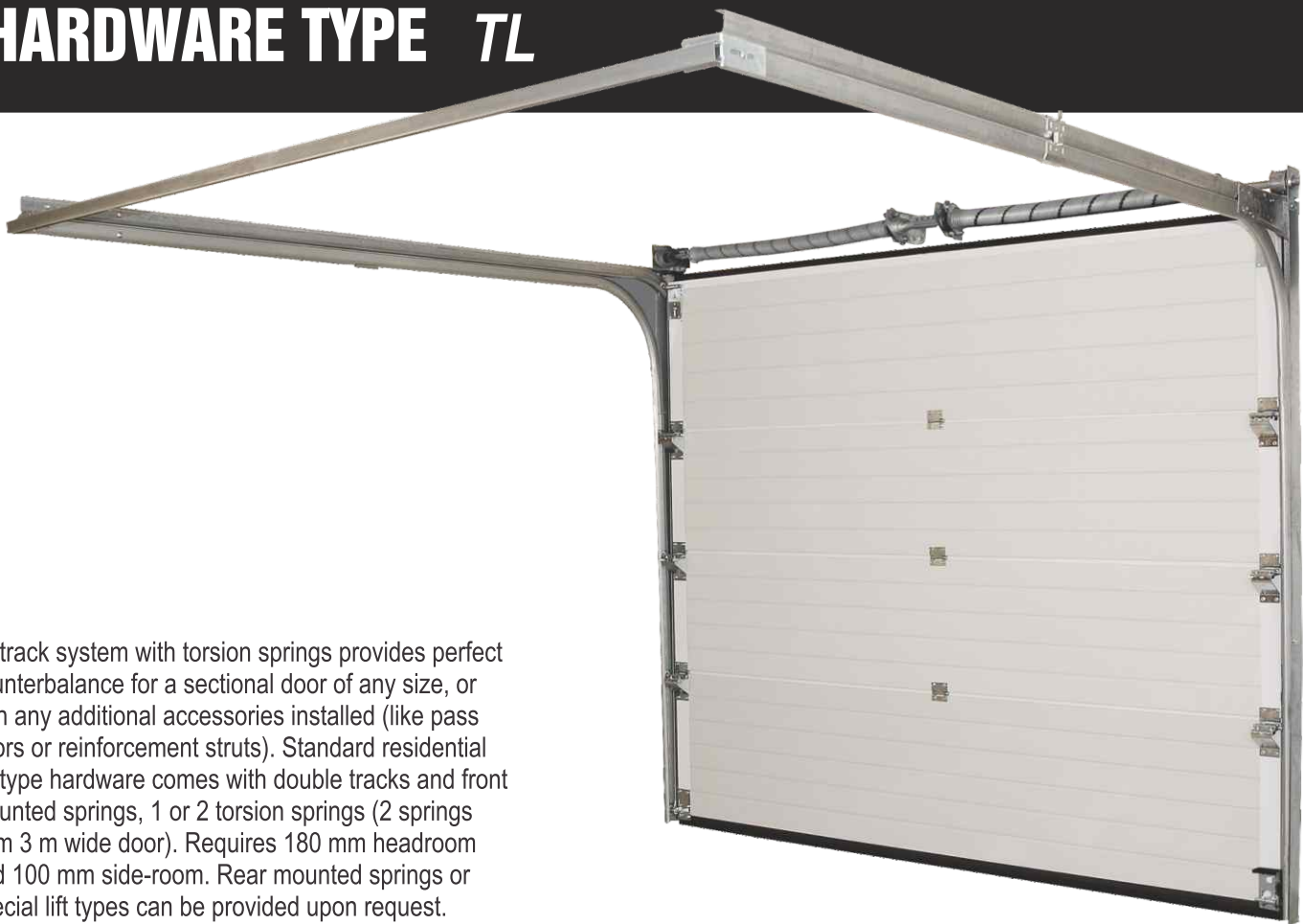

TL track system with torsion springs provides perfect counterbalance for a sectional door of any size, or with any additional accessories installed (like pass doors or reinforcement struts). Standard residential TL type hardware comes with double tracks and front mounted springs, 1 or 2 torsion springs (2 springs from 3 m wide door). Requires 180 mm headroom and 100 mm side-room. Rear mounted springs or special lift types can be provided upon request.

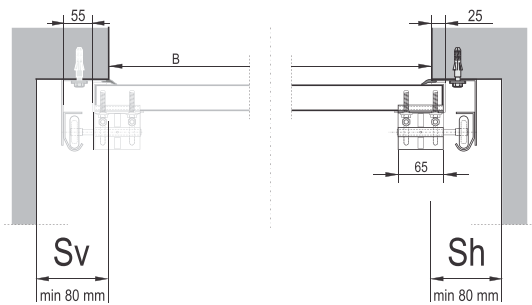

UNDER REQUEST

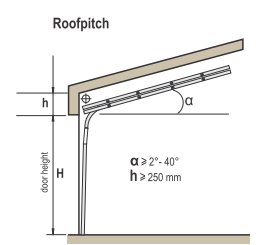
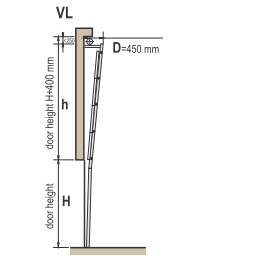
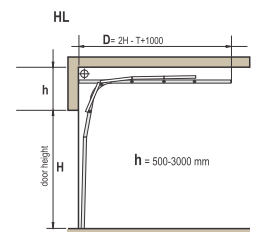
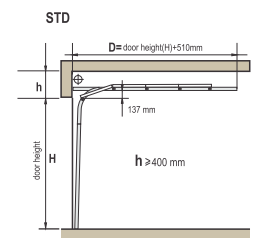

LHR FM - low headroom lift double tracks, front mounted springs

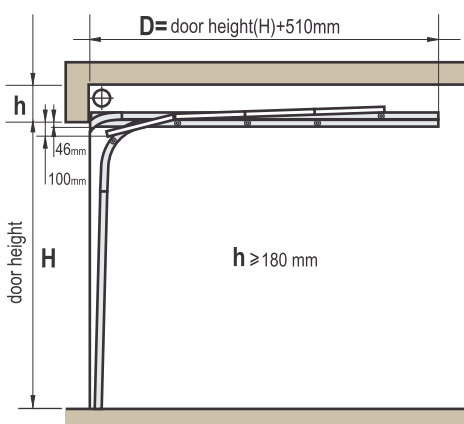

LHR RM - low headroom lift double tracks, rear mounted springs

